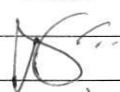

PURCHASE DIVISION
Advice for approval for credit to supplier

Date:		14/8/20		Prepared by:		SOWMYA	
PO/WO no.		69186		PO / WO Date.		27/7/20	
Supplier Name		Prityala E-tup.		PO/WO amount		15859	
Firm/Company		Sov LLP		Project		Sov LP	
Sl. No.	Bill No.	Bill Date	Bill amount				
1.	336	1/8/20	15859				
2.							
3.							
4.							
Amount A – Bills total(Excluding Transport & Hamali Charges):			15859				
Sl. No.	DC No	DC. Date	MRN No.	DC matches MRN			
1.			81727	<input checked="" type="checkbox"/> Yes <input type="checkbox"/> No			
2.				<input type="checkbox"/> Yes <input type="checkbox"/> No			
3.				<input type="checkbox"/> Yes <input type="checkbox"/> No			
4.				<input type="checkbox"/> Yes <input type="checkbox"/> No			
Amount B –Other Credits :							
Amount C –Other Debits :							
Amount D (D=A+B-C) – Amount to be credited to the supplier:			15859				
Amount E – PO / WO value:			15859				
Amount F – Difference (A – E):							
Quantity received as per PO /WO			<input checked="" type="checkbox"/> Yes <input type="checkbox"/> Excess received <input type="checkbox"/> Short received <input type="checkbox"/> Other (explained below)				
Is difference between PO / Bill acceptable?			<input type="checkbox"/> Yes <input type="checkbox"/> No (explained below)				
Excess / short material received			<input checked="" type="checkbox"/> Approved – within acceptable limits <input type="checkbox"/> No (explained below)				
Close PO / W?O			<input checked="" type="checkbox"/> Yes <input type="checkbox"/> No – wait for balance material <input type="checkbox"/> No (explained below)				
Advance paid / PDC given (deduct when paying)			<input type="checkbox"/> Yes – Rs. ___/- <input checked="" type="checkbox"/> No				
Payment – due date			21.8.2020				
Remarks:							
Approved by	Purchase Officer	Purchase Manager	Procurement Manager	MD	Accounts – receiver of bill	Accountant	Accounts Manager
Sign:							
Date	14/8/20						

Notes: 1. In case amount to be credited to supplier and the bills total does not match prepare JV for debit or credit. 2. Attach additional sheets if quantity of bills or DCs is more than the space provided. Clearly mark the space provided with 'see attachment'. 3. Purchase Officer can approve Pos/Wos upto Rs. 5,000/-, Purchase Manager and Procurement Manager to approve all bills from 5,000/- to 1,00,000/- . 4. Attach JV, Office copy of PO/WO, DCs and bills to this advice. 5. In Amount A, exclude transport, Hamali charges, etc and instead include in Amount B. 6. To be approved by accounts manager if bill value exceeds Rs. 10,000/- 7. MD to approve all bills above 1,00,000/-

GST NO: 36ADIPA6040M1ZL

TAX INVOICE

ORIGINAL



PRIYANKA ENTERPRISES

Distributors for : Ok Play, Little Genius Wooden Educational Aids,

Shop No. 12, City Towers, Opp. Metro Pillar No. 1430, Malakpet, Hyderabad - 500 036.

Tel : 2455 8658, 24546704, Cell : 98490 07177, 9849112001

EXCLUSIVE MONTESSORI PLAY SCHOOL EQUIPMENT HOUSE
INDOOR & OUTDOOR PLAY GROUND EQUIPMENT

ISO 9001 : 2015

M/s Silver oak Villas LLP
5-4-187/3 & 4, IInd floor, MG. Road
Secunderabad - 500003 36ADBF53288A2Z7INVOICE No. 336DATE: 01/08/2020Lr No: Lr Dt.: Transporter Name: 8919278620 NO.OF PACKS:

Party's GST NO: PO NO Date State Code:

S. No.	Name of The Product	HSN CODE	QTY	Price	Unit Price	AMOUNT	CGST		SGST		IGST		Total Amount
							Rate	Value	Rate	Value	Rate	Value	
1	Toodlers swing	9503	2	1550	1240	2480	6	148.80	6	148.80			2777.60
2	3 way Rocker	9503	1	2900		2320	6	139.20	6	139.20			2598.40
3	See Saw	9503	1	7500		6000	6	360	6	360			6720.00
4	Jr. Slide	9503	1	4200		3360	6	201.60	6	201.60			3763.20
TOTAL						14160		849.60		849.60			15859.20

INWARD WITH TIME:

Inward No: 11560 Dt: 1/8/20

MKN No: 81727 Dt: 4/8/2020

Received By: [Signature] Sign: [Signature]

SILVER OAK VILLAS LLP

Bank Details :- PRIYANKA ENTERPRISES

AXIS BANK LTD, Dilsukhnagar Branch
A/C NO: 235010200010548, IFSC Code: UTIB0000235
(Or)
HDFC BANK, Malakpet Branch,
A/C No: 02182530000085, IFSC Code: HDFC0000218
(Or)
SBI BANK, Sripuram Branch,
A/C No: 36338252074, IFSC Code: SBIN0060339

Total Amount Before Tax: 14160ADD CGST: 849.60ADD SGST: 849.60ADD IGST: -Total GST TAX Amount: 1699.20Total AMOUNT: 15859.20

Amount in Words :

Terms & Conditions:

Payment to be made by Cheque/DD/NEFT/RTGS in favour of M/s. PRIYANKA ENTERPRISES.
Our Responsibility ceases as soon as the goods have been delivered to the carriers.
No claims for Breakages and shortage during transit will not be entertained. All disputes subject to Hyderabad Jurisdiction only.

Receiver's Signature & Stamp:

Received By:

Phone Number:

For PRIYANKA ENTERPRISES

Authorised Signatory

Purchase Order



69186

31.07.20 12:08:29

Page(s) 1 Of 1

28-Jul-20 12:37:19 PM

From Company : **Silver Oak Villas LLP**
5-4-187/3 & 4, IInd Floor, M.G.Road, Secunderabad - 500003
G S T No. : 36ADBFS3288A2Z7

Supplier Details

PRIYANKA ENTERPRISES
S.No.12, City Towers, Nalgonda X Roads, Malakpet, Hyderabad - 500
036.

GSTIN -

040 - 24558658 / 24546704

9849007177

Doc No	69186	155895
Doc Date	27-07-2020	
Quote No	Nil	
Quote Date	27-07-2020	
SupplyType	Supply	

Kind Attn : **Mr.Janardhan.(janardhan.eduneeds@gmail.com)**

Purchase Order for the Supply of following Items.

Item Name	Qty	Rate	Dis%	IGST	Amount
1 5110 - Equipment - sports - Swinging Looprung - NA - nos Toodlers swing, Model 1050	2.00	1,550.00	20.00	12.00	2,777.60
2 5055 - Equipment - sports - 3-way Rocker - NA - nos Model 2010	1.00	2,900.00	20.00	12.00	2,598.40
3 5103 - Equipment - sports - Sea Saw - NA - nos Model 2030	1.00	7,500.00	20.00	12.00	6,720.00
4 5108 - Equipment - sports - Slide - Junior - nos Model 1010	1.00	4,200.00	20.00	12.00	3,763.20
Total Order Value . . .					15,859.20

Rupees : Fifteen Thousand Eight Hundred Fifty Nine and Paise Twenty Only.

Terms and Conditions :-

Specification / Brand	All items are of OK ply as per the catalog
Payment Terms	After delivery and production of bill
Tax	Included in the above prices
Delivery Date	With in 1 week
Delivery Location	Silver Oak Villas Phase - IX Sy. No. 291, Cherlapally, Hyderabad, next to Govt. of india mint Phone. Contact: Security 65908777, 9502288244 Sanjay
Penalty For Delay	Nil
Transportation Cost	Nil
Warranty	Nil
Advance Paid	Nil
Other Terms	We reserve the rights to reject the items if not as specified, damages if any in suppliers account, above order is for TOT-LOT-3 Children play area purpose.
Completion Date	Nil
Measurment	Nil
Security	Nil
Remarks	Nil

For **Silver Oak Villas LLP**

Authorised Signatory

Name : _____

Accepted the above Terms And Conditions

For **PRIYANKA ENTERPRISES**

Date : ___/___/___

Estimate/Draft PO

Page(s) 1 Of 1

27-Jul-20 2:04:35 PM

Original / Office Copy / Purchase Div.Copy

From Company : **Silver Oak Villas LLP**
5-4-187/3 & 4, IInd Floor, M.G.Road, Secunderabad - 500003
G S T No. : 36ADBFS3288A2Z7

Supplier Details

PRIYANKA ENTERPRISES
S.No.12, City Towers, Nalgonda X Roads, Malakpet, Hyderabad - 500036.

GSTIN -

040 - 24558658 / 24546704

9849007177

Doc No	69186	155895
Doc Date	27-07-2020	
Quote No	Nil	
Quote Date	27-07-2020	
SupplyType	Supply	

Kind Attn : **Mr.Janardhan.(janardhan.eduneeds@gmail.com)**

Estimate/Draft PO for the Supply of following Items.

Item Name	Qty	Rate	Dis%	IGST	Amount
1 5110 - Equipment - sports - Swinging Looprung - NA - nos Toodlers swing, Model 1050	2.00	1,550.00	20.00	12.00	2,777.60
2 5055 - Equipment - sports - 3-way Rocker - NA - nos Model 2010	1.00	2,900.00	20.00	12.00	2,598.40
3 5103 - Equipment - sports - Sea Saw - NA - nos Model 2030	1.00	7,500.00	20.00	12.00	6,720.00
4 5108 - Equipment - sports - Slide - Junior - nos Model 1010	1.00	4,200.00	20.00	12.00	3,763.20
Total Order Value . . .					15,859.20

Rupees : Fifteen Thousand Eight Hundred Fifty Nine and Paise Twenty Only.

Terms and Conditions :-

Specification / Brand All items are of OK ply as per the catalog

Payment Terms After delivery and production of bill

Tax Included in the above prices

Delivery Date With in 1 week

Delivery Location Silver Oak Villas Phase - IX

Sy. No. 291, Cherlapally, Hyderabad, next to Govt. of india mint

Phone. Contact: Security 65908777, 9502288244 Sanjay

Penalty For Delay Nil

Transportation Cost Nil

Warranty Nil

Advance Paid Nil

Other Terms We reserve the rights to reject the items if not as specified, damages if any in suppliers account, above order is for TOT-LOT-3 Children play area purpose.

Completion Date Nil

Measurment Nil

Security Nil

Remarks Nil

APPROVED BY
27 JUL 2020
SOHAM NIGI
MANAGING DIRECTOR

PS
27/7/20

For **Silver Oak Villas LLP**

Authorised Signatory

Accepted the above Terms And Conditions

For **PRIYANKA ENTERPRISES**

Name : _____

Name : _____

Date : ___/___/___

Requisition Form

Company Name:	Silver Oak Villas LLP	Date:	22-07-2020
Site & Phase :	Silver Oak Villas	Time:	10.51
Supplier		Req. No.	155895
Material required before date:	02-08-2020	ID No.	58672

No	Description	Size	Quantity	Units	Inward No	Date
1	OK Play Equipment	-	06	Nos		
2						
3						
4						
5						
6						
7						
8						
9						
10						

69188

Catalog a present price needed.

Remarks: - For TOT- LOT-3 Children Play Area Purpose

Prepared By	K.PURSHOTHAM	Approved by	
Sign. & Date	22-07-2020	Sign. & Date	

APPROVED BY

22 JUL 2020

SOHAM MOJI
MANAGING DIRECTOR

Note: On receipt of material at site write inward number and date in last 2 columns.

Company Name:		Date:	
Site & Phase :		Time:	15.00
Supplier		Req. No.	
Material required before date:	28.03.17	ID No.	

No	Description	Size	Quantity	Units	Inward No	Date
1						
2						
3						
4						
5						
6						
7						
8						
9						
10						

Remarks: -

Prepared By	K.PURSHOTHAM	Approved by	
Sign. & Date		Sign. & Date	

Note: On receipt of material at site write inward number and date in last 2 columns.

PRIYANKA ENTERPRISES

(Exclusive Play School Equipment House)

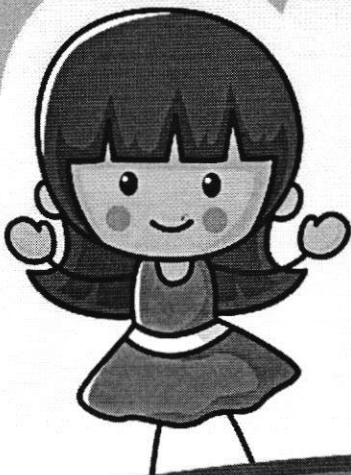

It's a small world

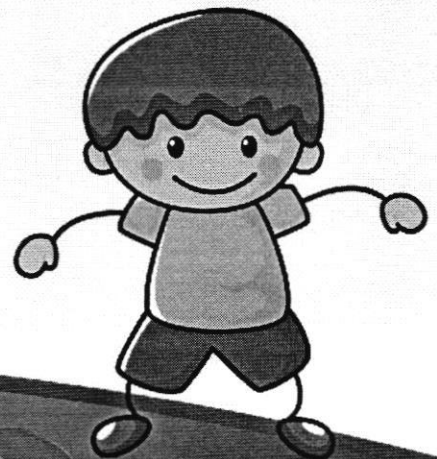

www.smileplayindia.com

PLAY ITEMS

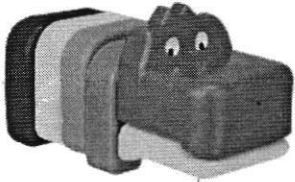

3300
MY PET HIPPO

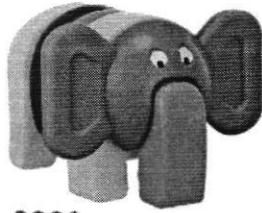

3290
MY PET ELEPHANT

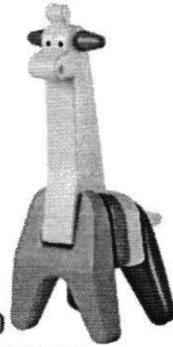

3310
MY PET GIRAFFE

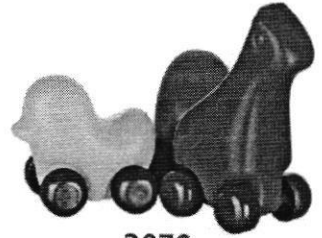

3070
LITTLE PETS

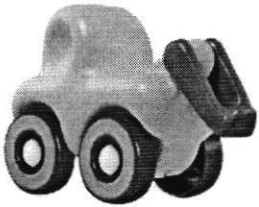

3040
MY FIRST TRUCK-I

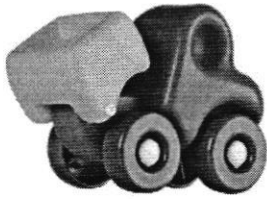

3050
MY FIRST TRUCK-II

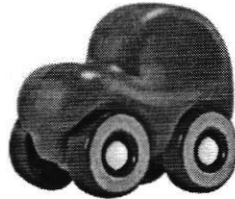

3060
MY FIRST TRUCK-III



6570
WORLD CUP CRICKET

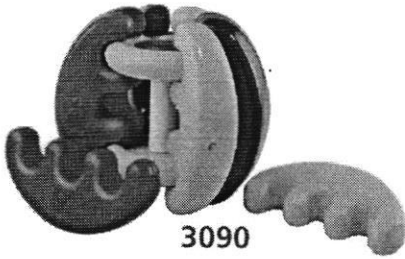

3090
WONDER BALL



3350
JUNIOR BOWLING ALLEY

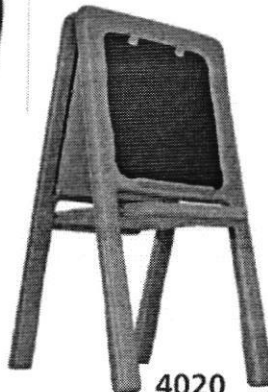

4020
THE EASEL

18\$ ✓
25/27 ✓
2007 ✓

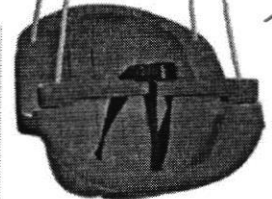

1050
TODDLER'S SWING

3270
FUNNY BUNNY LINK

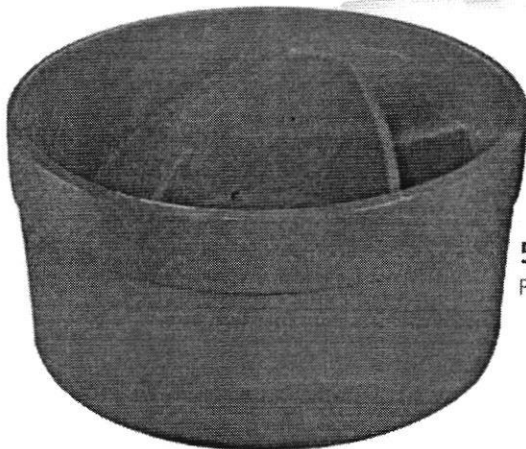
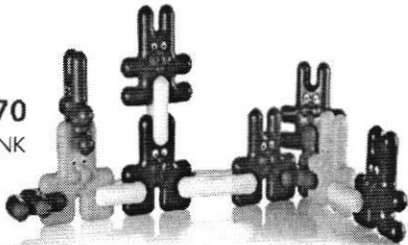

5010
PLAY POOL



4030
EASEL GRAND

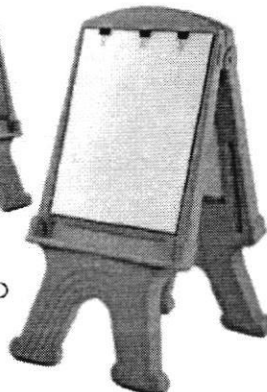

2060
FUN FLIER



RIDEONS

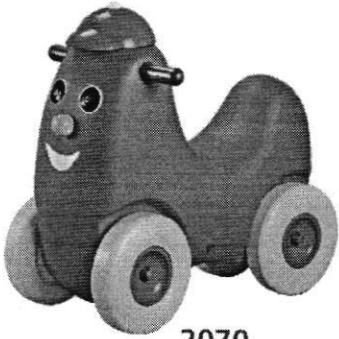

2070
HUMPTY DUMPTY



2090
MY PET RIDE ON



4050
SCOOT HOOT



2080
STREET HAWK

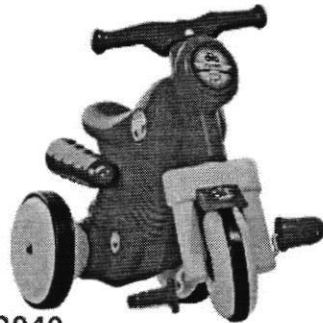

2040
TURBO



2120
PACER

ROCKERS

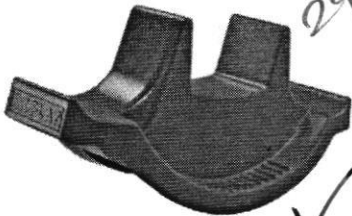

2010
3 WAY ROCKER

2900
✓
w
25/7



2160
ROXY TWO-IN-ONE

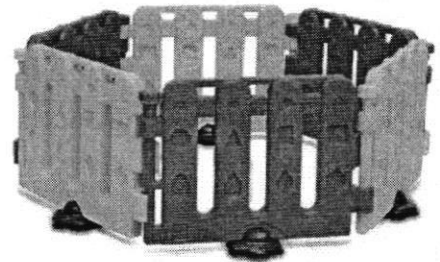

3330
PLAY PEN

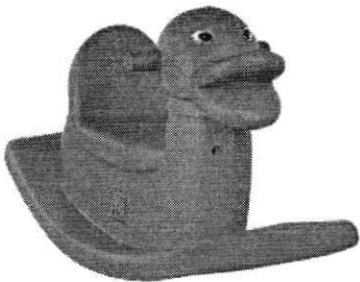

2170
DUCK ROCKER

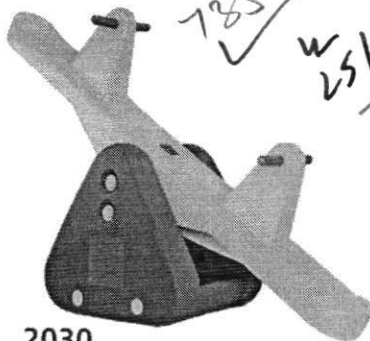

2030
SEE SAW

7850
✓
w
25/7



10220
SPIN-O-ROUND

SLIDES



1010
SUPER SLIDER

*w 4350
25/7*

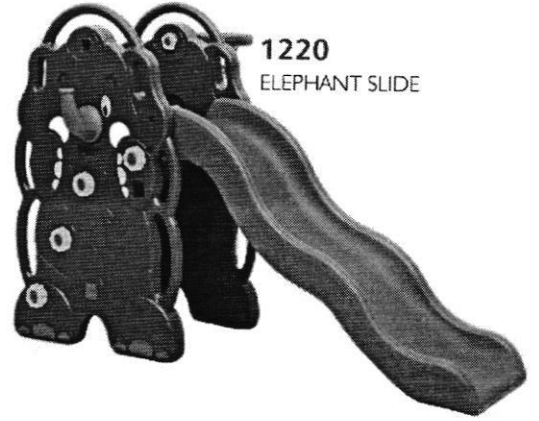

1220
ELEPHANT SLIDE

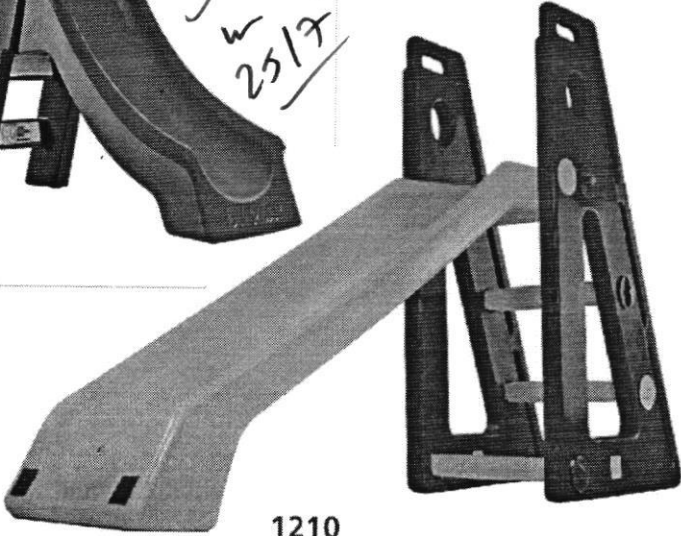

1210
BABY SLIDE SENIOR

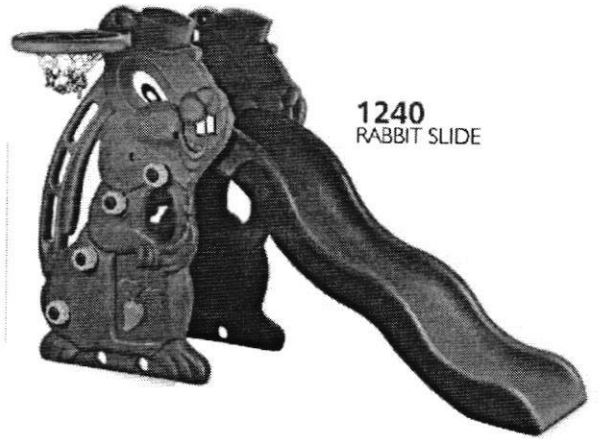

1240
RABBIT SLIDE

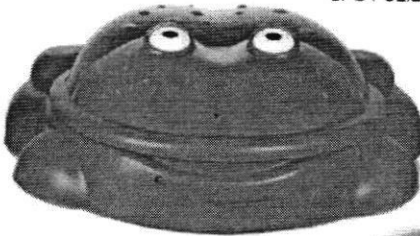

10270
SAND PIT

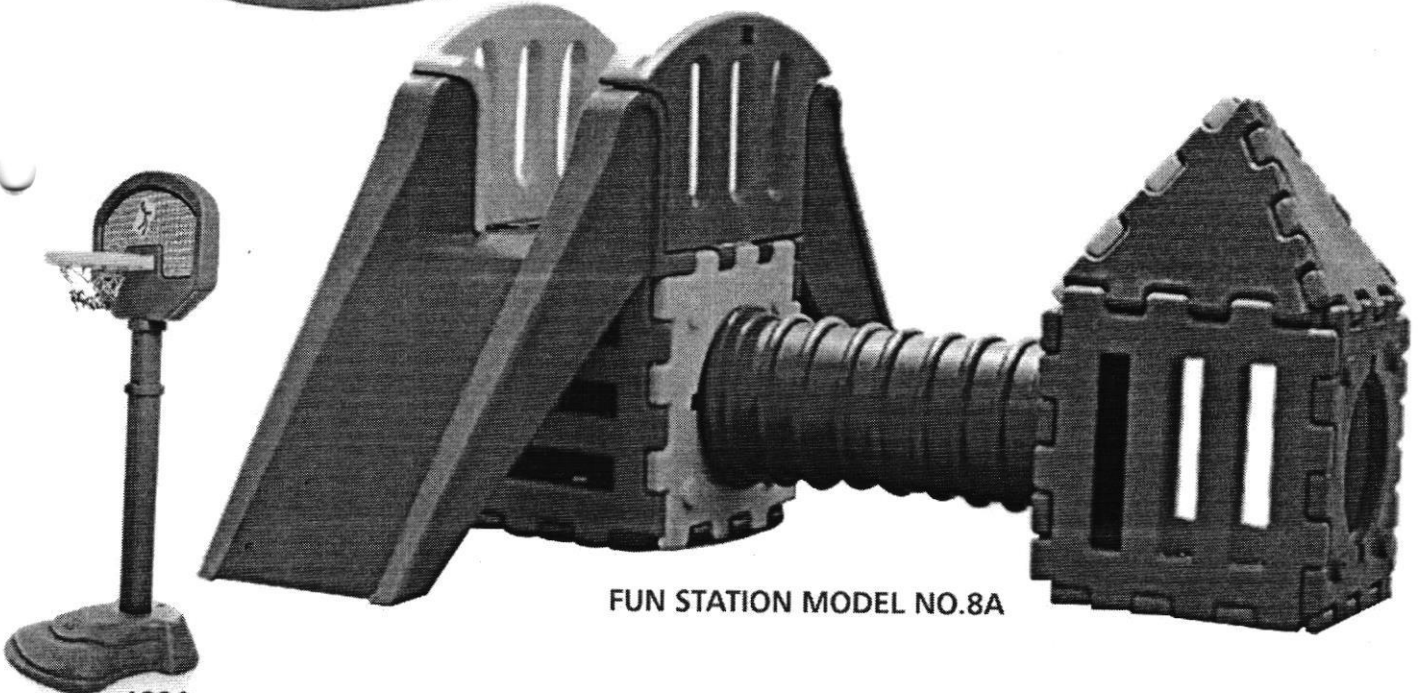

FUN STATION MODEL NO.8A



1230
BASKET BALL RING

FURNITURE



9730
ROUND TABLE



260
MOON DESK



8070
PLAY PET DOUBLE

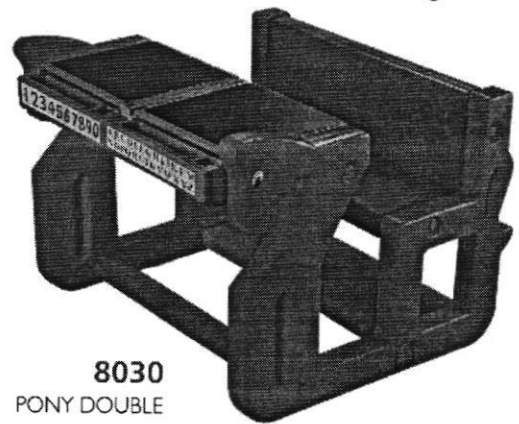

8030
PONY DOUBLE



8090
LITTLE SCHOLARS



9140
SENIOR SCHOLARS



9360
OK STUDY MASTER DOUBLE



9370
OK STUDY MASTER SINGLE

OUTDOOR PLAY STATIONS



ACACIA MODEL OK_FNS_001

Product Dimensions (L x W x H)
20'0" x 16'6" x 13'0" ft
Recommended Area (L x W)
30'0" x 26'0" ft

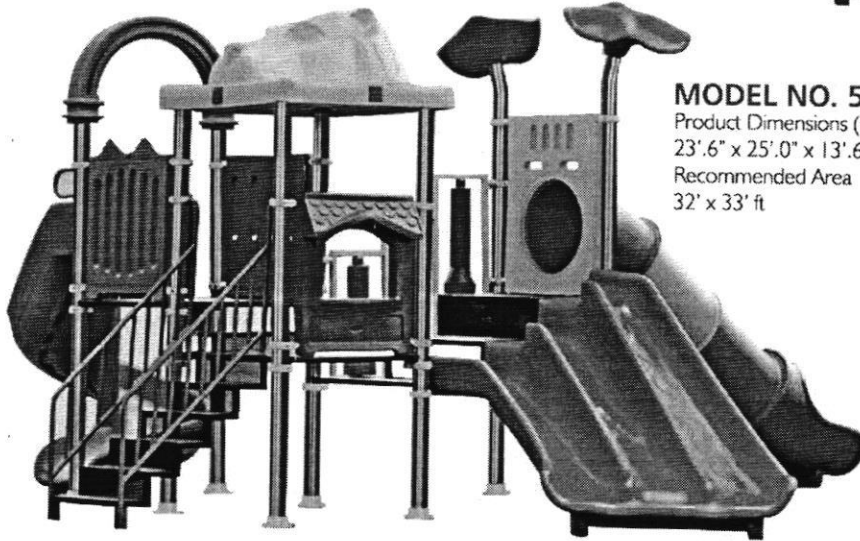

MODEL NO. 52

Product Dimensions (L x W x H)
23'.6" x 25'.0" x 13'.6" ft
Recommended Area
32' x 33' ft

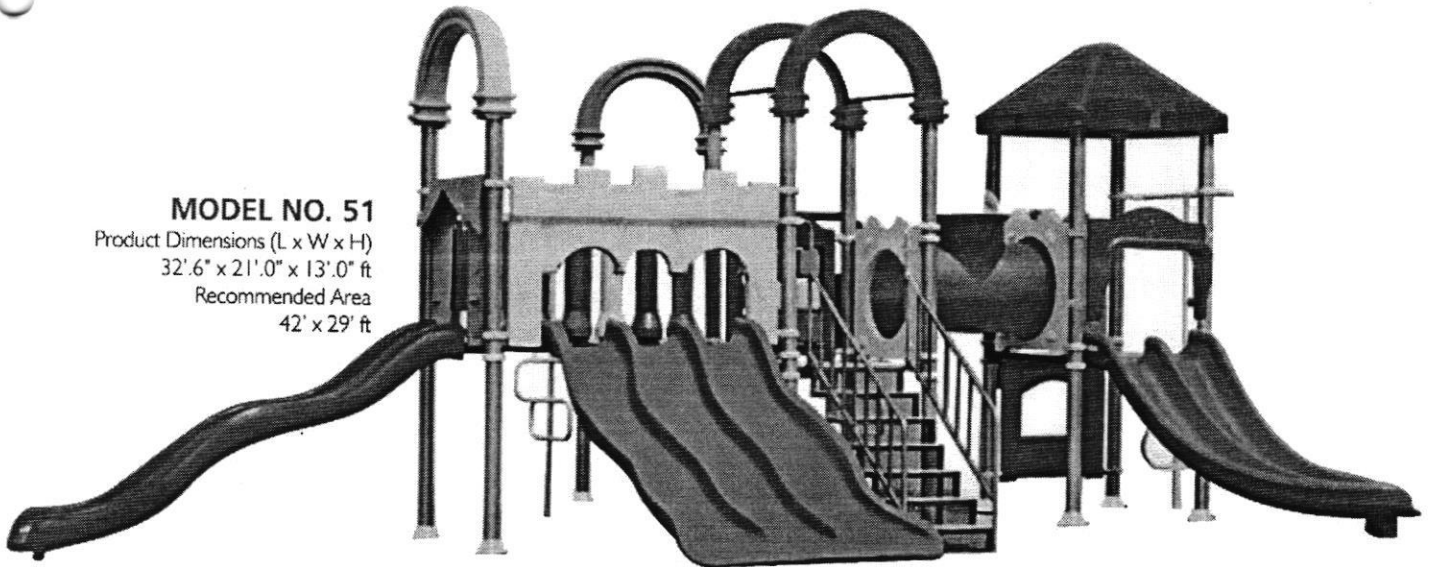

MODEL NO. 51

Product Dimensions (L x W x H)
32'.6" x 21'.0" x 13'.0" ft
Recommended Area
42' x 29' ft

LOW COST OUTDOOR PLAY STATIONS

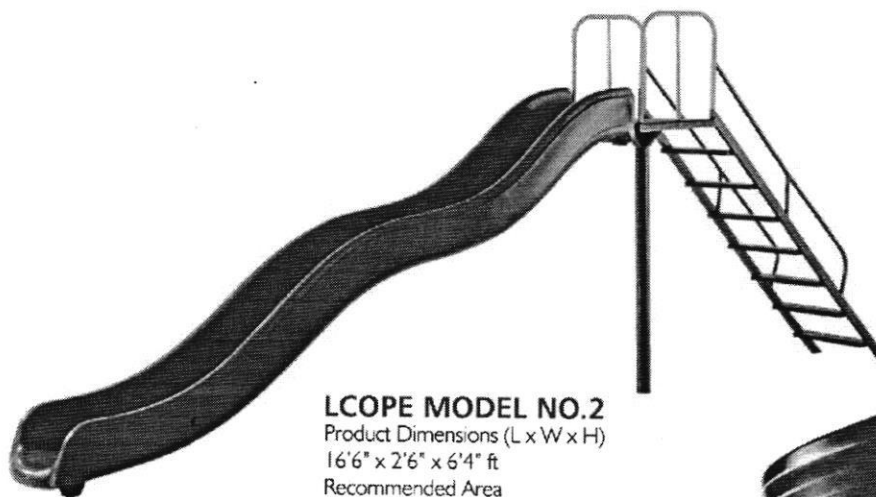

LCOPE MODEL NO.2
Product Dimensions (L x W x H)
16'6" x 2'6" x 6'4" ft
Recommended Area
25'6" x 8'6" ft

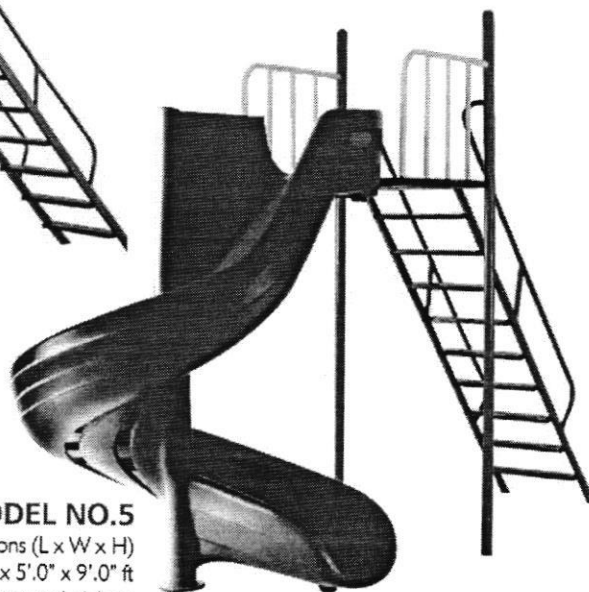

LCOPE MODEL NO.4
Product Dimensions (L x W x H)
20' x 12'3" x 8'6" ft
Recommended Area
29' x 20'3" ft



LCOPE MODEL NO.5
Product Dimensions (L x W x H)
13'0" x 5'0" x 9'0" ft
Recommended Area
20' x 13' ft

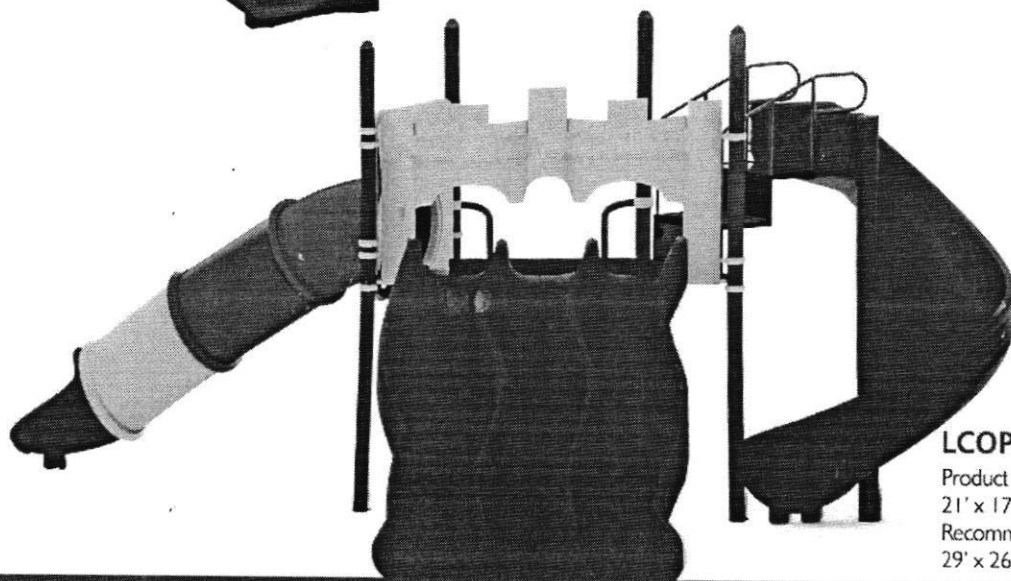

LCOPE MODEL NO.13
Product Dimensions (L x W x H)
21' x 17'6" x 10' ft
Recommended Area
29' x 26'6" ft

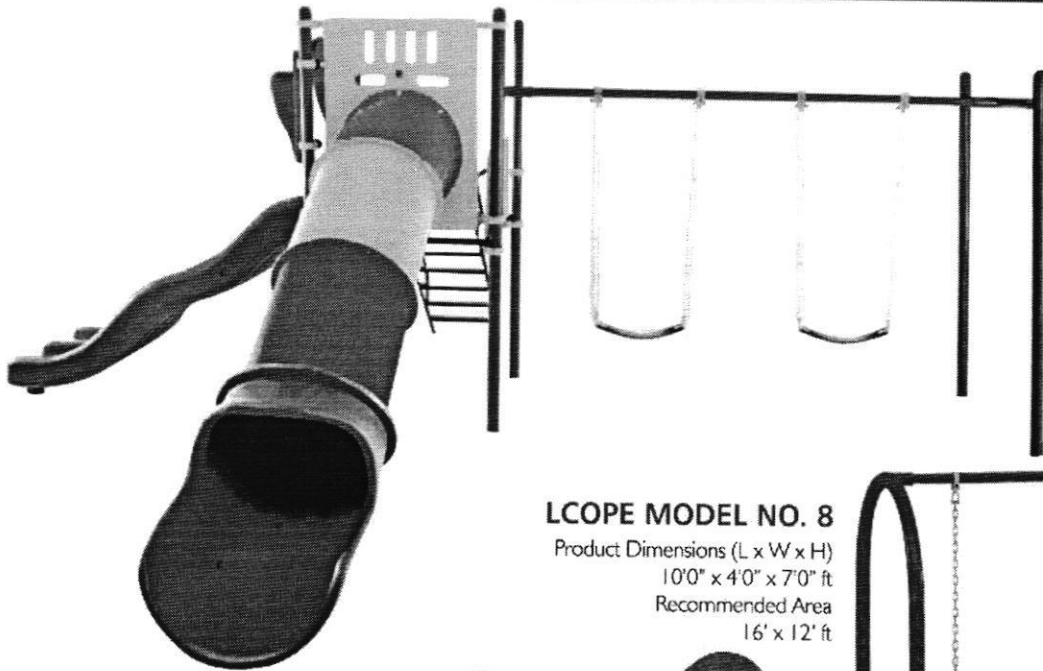

LCOPE MODEL NO.6

Product Dimensions (L x W x H)
22'3" x 20'0" x 8'6" ft
Recommended Area
30'3" x 29' ft



LCOPE MODEL NO. 8

Product Dimensions (L x W x H)
10'0" x 4'0" x 7'0" ft
Recommended Area
16' x 12' ft



OK_STA_022

Product Dimensions (L x W x H)
2'9" x 17'0" x 3'0" (H) ft.

OK_STA_017

Product Dimensions (L x W x H)
6'4" x 1'6" x 2'5" ft

OK_STA_008

Product Dimensions (L x W x H)
83 (Dial) x 68 (H) ft.

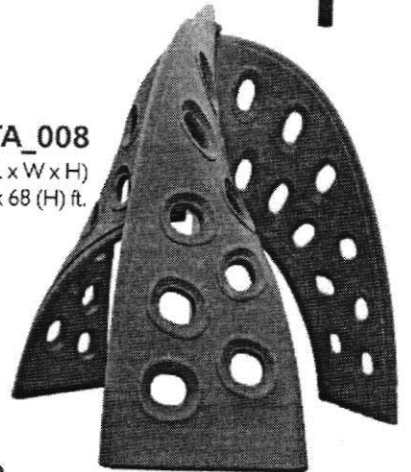

OK_STA_024

Product Dimensions (L x W x H)
2'7" x 1'11" x 3'0" (H) ft.

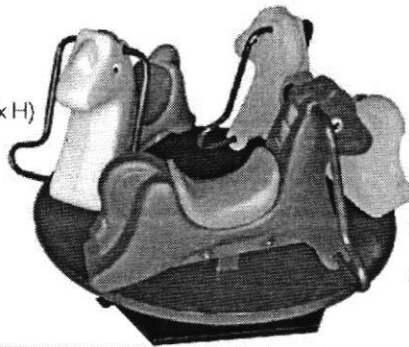

OK_STA_020

Product Dimensions (L x W x H)
3'10" (Dial) x 2'9" (H) ft.

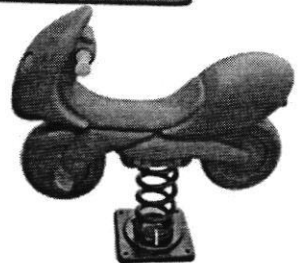

OK_STA_023

Product Dimensions (L x W x H)
2'7" x 1'10" x 3'0" (H) ft.

Sole Distributor for Telangana & Andhra Pradesh

PRIYANKA ENTERPRISES

(Exclusive Play School Equipment House)

12, City Towers, Diagonally Opp. Yashoda Hospital, Malakpet, Hyderabad - 500036.

Web: www.smileplayindia.com E-mail: priyanka_educaids@yahoo.co.in

Ph: 040-2455 8658, 2454 6704 Cell: +91 98490 07177, +91 98491 12001

2017 Special Discounted Price List

Code	Product Name	Price
3300	My Pet Hippo	290
3290	My Pet Elephant	290
3310	My Pet Giraffe	290
3070	Little Pets	380
3040	My First Truck- I	390
3050	My First Truck- II	390
3060	My First Truck- III	390
6570	World Cup Cricket	1550
3090	Wonder Ball	550
3350	Junior Bowling Alley	850
4020	The Easel	6500
3270	Funny Bunny Link	950
1050	Swing	1850
5010	Play Pool	42000
4030	Easel Grand	6500
2060	Fun Flier	1250
2070	Humpty Dumpty	1890
2090	My Pet Ride On	1890
4050	Scoot Hoot	2800
2080	Street Hawk	2550
2040	Turbo	2550
2120	Pacer	3150
2010	3 Way Rocker	2920
2160	Roxy 2-in- I	4200
3330	Play Pen	8900
2170	Duck Rocker	2150
2030	See Saw	7350
10220	Spin-o-round	9900
1010	Super Slider	4350
1210	Baby Slide Senior	9250
1220	Elephant Slide	11500
1240	Rabbit Slide	11500
10270	Sandpit	6900
1230	Basket Ball	5450
	Fun Station Model No: 8A	89000

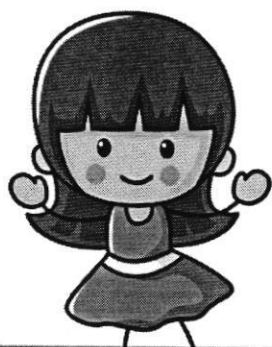

Sole Distributor for Telangana & Andhra Pradesh

PRIYANKA ENTERPRISES

(Exclusive Play School Equipment House)

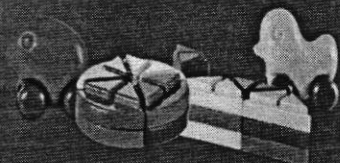
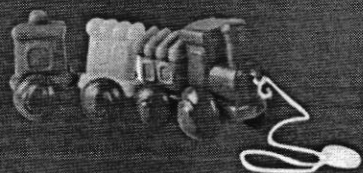

2017 Special Discounted Price List

Code	Product Name	Price
9730	Round Table	8670
260	Moon Desk	8720
8070	Play Pet Double	8490
8030	Pony Double	8490
8090	Little Scholar	7560
9140	Senior Scholar	9130
9360	OK Study Master Double	11530
9370	OK Study Master Single	7380
	ACACIA Model Ok_Fns_001	330000
	LCOPE Model No.02	45000
	LCOPE Model No.05	98000
	LCOPE Model No.04	150000
	LCOPE Model No.13	260000
	LCOPE Model No.06	185000
	LCOPE Model No.08	55000
	Ok_Sta_017	32000
	Ok_Sta_008	72000
	Ok_Sta_022	19000
	Ok_Sta_020	45000
	Ok_Sta_024	19000
	Ok_Sta_023	19000

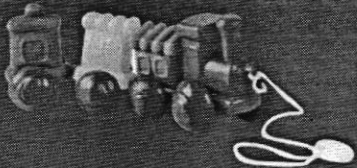
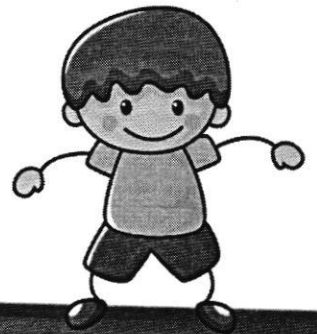
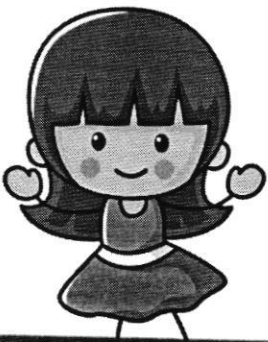

Sole Distributor for Telangana & Andhra Pradesh
PRIYANKA ENTERPRISES
 (Exclusive Play School Equipment House)

